

# UT65CML8X8FD-EVB-UM Evaluation Board

## 1.0 Introduction

The UT65CML8X8FD-EVB Evaluation Board provides a comprehensive platform for evaluating the UT65CML8X8FD 3.125 Gbps Crosspoint Switch (XPS). The XPS is configured via the internal registers as specified in the register map section of the data sheet. Internal registers are configured via the XPS SPI port. A Software (SW) Graphical User Interface (GUI) is provided with the UT65CML8X8FD-EVB to facilitate setup of the XPS device. Users can specify high-speed signal routing paths, input receiver (RX) equalization (EQ), output transmitter (TX) amplitude, and all other User-configurable operating parameters through the SW GUI. This User Guide serves to provide setup and operation of the UT65CML8X8FD-EVB, including both Hardware (HW) and Software (SW).

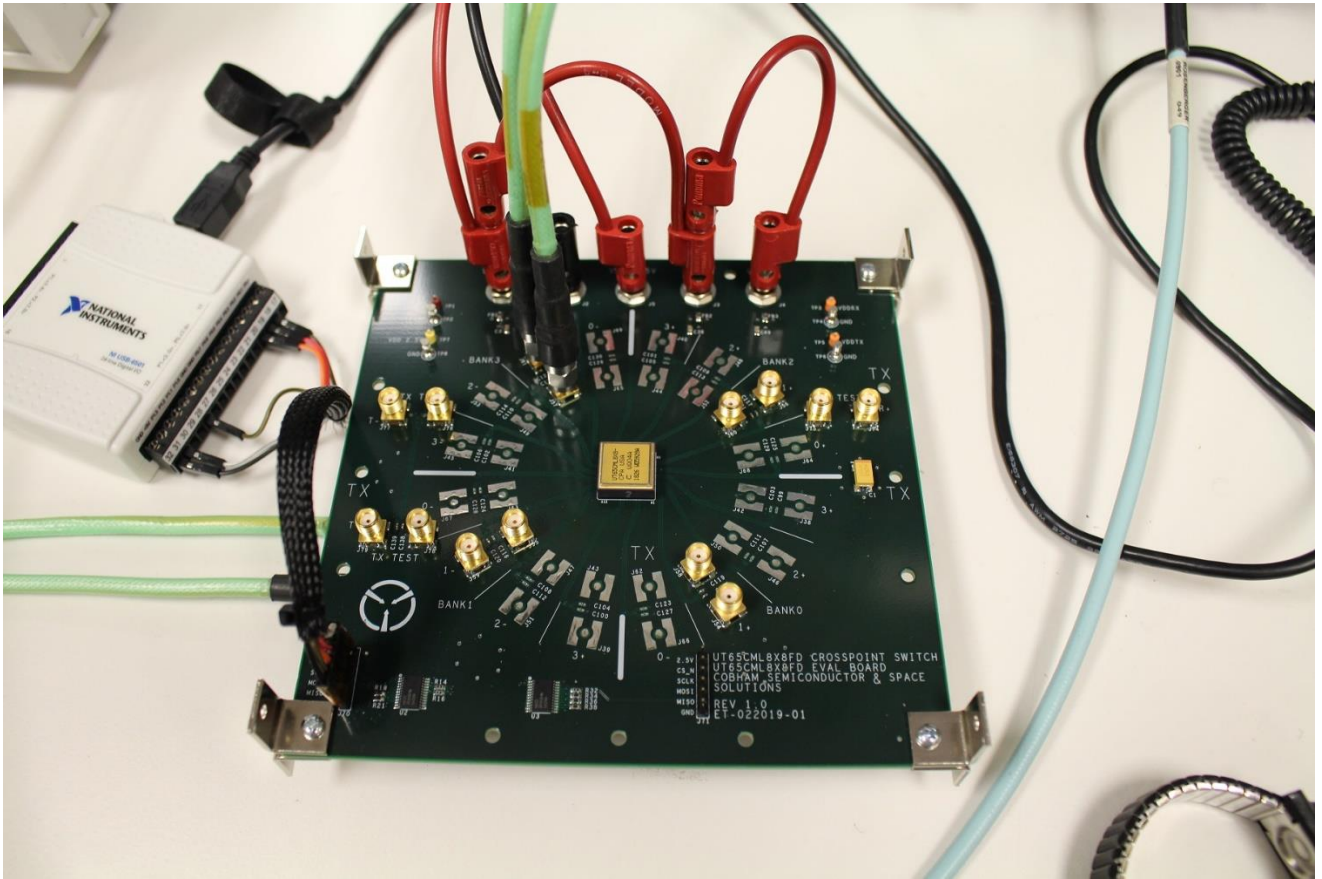

Figure 1: UT65CML8X8FD-EVB Crosspoint Switch Evaluation Board Top View (TX Side)

3.125 Gbps Crosspoint Switch (XPS)

# UT65CML8X8FD-EVB-UM Evaluation Board

## 2.0 Reference Documents

Description	Reference Document
UT65CML8X8FD XPS 1) Data Sheet	<a href="https://caes.com/products/radiation-hardened-solutions-high-reliability-components/interconnect/crosspoint-switch">https://caes.com/products/radiation-hardened-solutions-high-reliability-components/interconnect/crosspoint-switch</a>  <a href="https://caes.com/sites/default/files/documents/Datasheet-UT65CML8X8FD.pdf">https://caes.com/sites/default/files/documents/Datasheet-UT65CML8X8FD.pdf</a>
UT65CML8X8FD-EVB 1) PCB Layout Information 2) EVB GUI SW 3) EVB User Manual	<a href="https://caes.com/product/ut65cml8x8fd#downloads">https://caes.com/product/ut65cml8x8fd#downloads</a>

## 3.0 Evaluation Kit Contents

- UT65CML8X8FD-EVB 3.125 Gbps Crosspoint Switch (XPS) Evaluation Board (EVB) (1) – Populated with SMA Jacks + AC-Coupling Capacitors for 1 of 4 Channels Only: Channel 1 for All Ports 0-3.
- UT65CML8X8FD-EVB XPS Evaluation Board GUI Software (1)
- National Instruments (NI) USB-6501 USB-to-SPI Interface Device (1)
- USB AB 2.0 Cable (1) – Laptop PC to NI USB-6501 USB Interface
- NI USB-6501 SPI Interface Custom Cable Assembly (1) - NI USB-6501 to EVB SPI Port Interface
- UT65CML8X8FD-EVB-UM Evaluation Kit User Manual (1)

# UT65CML8X8FD-EVB-UM Evaluation Board

## 4.0 Table of Contents

### Table of Contents

1.0	Introduction .....	1
	Figure 1: UT65CML8X8FD-EVB Crosspoint Switch Evaluaton Board Top View (TX Side) .....	1
2.0	Reference Documents .....	2
3.0	Evaluation Kit Contents .....	2
4.0	Table of Contents .....	3
5.0	Evaluation Board (EVB) Configuration.....	4
	Figure 2: UT65CML8X8FD-EVB Crosspoint Switch Evaluaton Board – Top View (TX Side) Mounted with C-BGA Proto DUT.....	4
	Figure 3: UT65CML8X8FD-EVB Crosspoint Switch Evaluaton Board – Bottom View (RX Side).....	5
6.0	Test Equipment List .....	6
7.0	Test Equipment setup diagram .....	7
	Figure 4: Test Equipment Setup Diagram.....	7
8.0	Operating Instructions.....	8
	Figure 5a: Evaluation Board Test Configuration – All Possible XPS Connections .....	8
	Figure 5b: Evaluation Board Test Configuration – Default XPS Connections.....	9
	Figure 6: Example UT65CML8X8FD-EVB Test Equipment Setup .....	10
	Figure 7: NI USB-6501 USB-to-SPI Interface Device with Interface Cable.....	10
	Figure 8: Detailed View of EVB Master SPI Port Header + Cable Assembly Connector Interface.....	11
	Figure 9: XPS GUI “Miscellaneous” Settings Tab Parameters .....	12
	Figure 10: XPS GUI “Receiver (RX)” Settings Tab Parameters.....	12
	Figure 11: XPS GUI “Transmitter (TX)” Settings Tab Parameters .....	13
	Figure 12: Schematics 1/5 .....	14
	Figure 13: Schematics 2/5 .....	15
	Figure 14: Schematics 3/5 .....	16
	Figure 15: Schematics 4/5 .....	17
	Figure 16: Schematics 5/5 .....	17
	Figure 17: Bill of Materials (BoM).....	19
11.0	EVB Layout Information.....	20
12.0	Revision History .....	20

3.125 Gbps Crosspoint Switch (XPS)

# UT65CML8X8FD-EVB-UM Evaluation Board

## 5.0 Evaluation Board (EVB) Configuration

5a) EVB - Top View (TX Side)

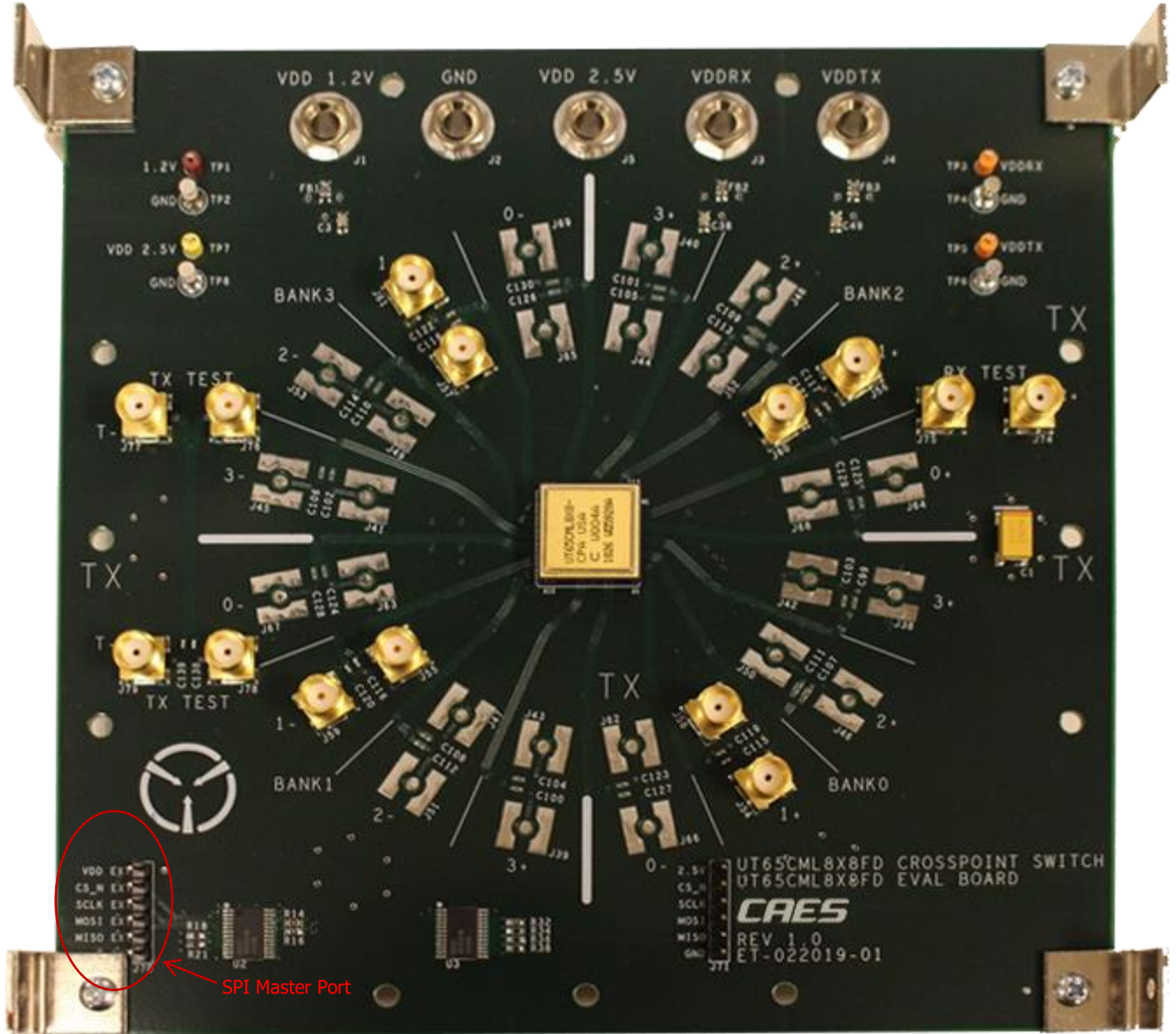

Figure 2: UT65CML8X8FD-EVB Crosspoint Switch Evaluation Board – Top View (TX Side) Mounted with C-BGA Proto DUT

5b) EVB - Bottom View (RX Side)

# UT65CML8X8FD-EVB-UM Evaluation Board

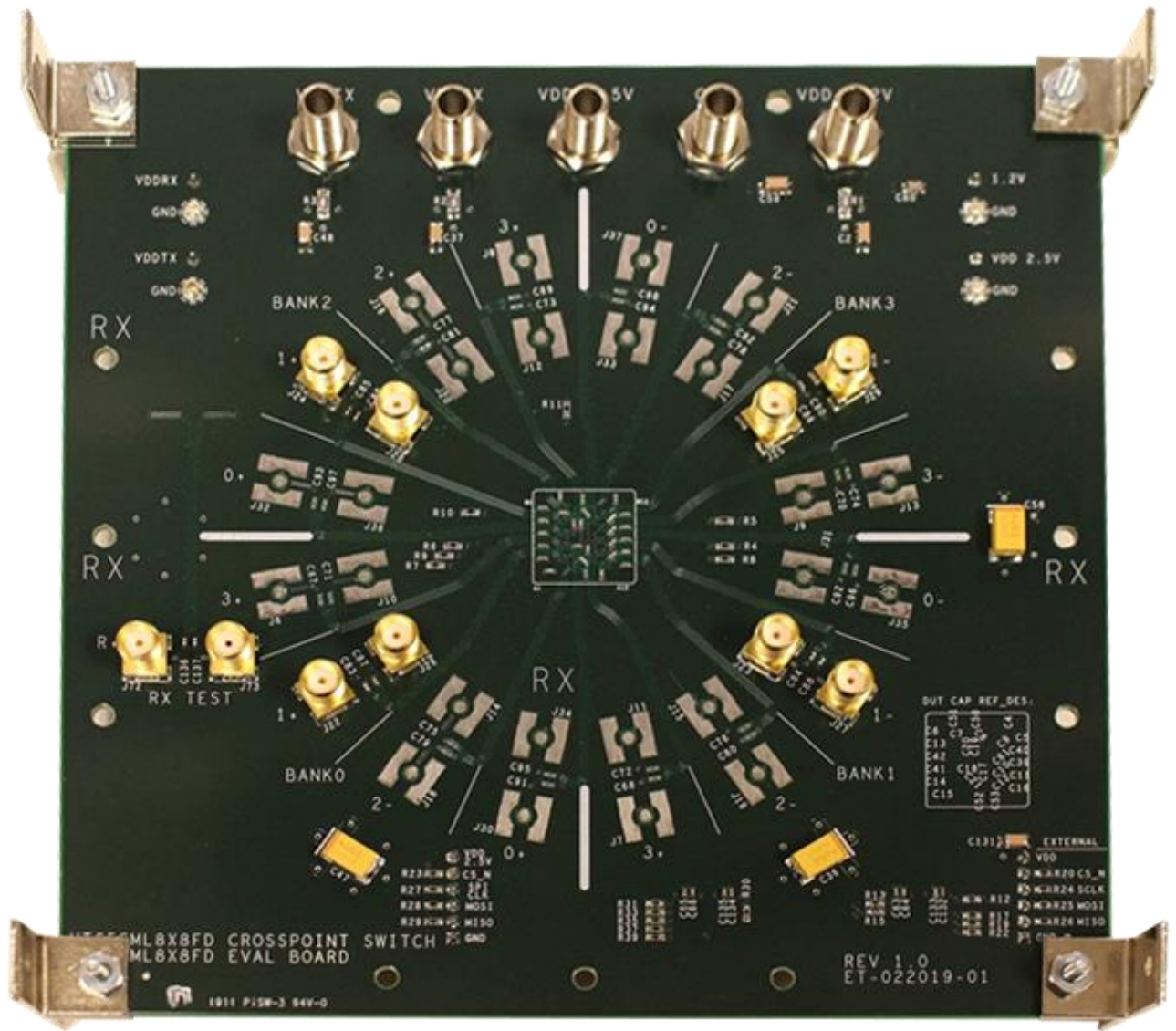

Figure 3: UT65CML8X8FD-EVB Crosspoint Switch Evaluation Board – Bottom View (RX Side)

# UT65CML8X8FD-EVB-UM Evaluation Board

## 6.0 Test Equipment List

Item #	Description	Function/Purpose	Quantity
*1	UT65CML8X8FD XPS Evaluation Board Rev. 2.0 with BGA Proto Soldered DUT	XPS Evaluation Board Rev. 2.0	1
2	Differential Output 3.125 Gbps Pattern Generator (PRBS/XAUI/etc.)	Pulse Pattern Generator for Input Stimulus	1
3	Differential input oscilloscope with input analog bandwidth (BW) $\geq 8\text{GHz}$	Oscilloscope for Output Display	1
4	2-3 Channel DC Power Supply	DC Power Supply for XPS Evaluation Board (1.2V, 1.5-1.8V (optional), 2.5V)	1
5	MS Windows Laptop Computer	Platform for SW GUI Operation	1
*6	GUI SW to be installed on (5)	Configure the XPS Internal Registers	1
*7	USB AB 2.0 Cable	Laptop to NI USB-6501 Interface Cable	1
*8	NI USB-6501 USB-to-SPI Interface Device	USB-to-SPI Interface Device (USB B input)	1
*9	NI USB-6501 SPI Interface Custom Cable Assembly	Connects NI USB-6501 to EVB SPI Port	1
10	SMA Cables	High-Speed Signal Connections To/From DUT and Test Equipment	4+
11	DC Banana Plug Power Cables	Evaluation Board DC Power Connections	5-6

\* Provided as BoM line item of the XPS Evaluation Kit

# UT65CML8X8FD-EVB-UM Evaluation Board

## 7.0 Test Equipment setup diagram

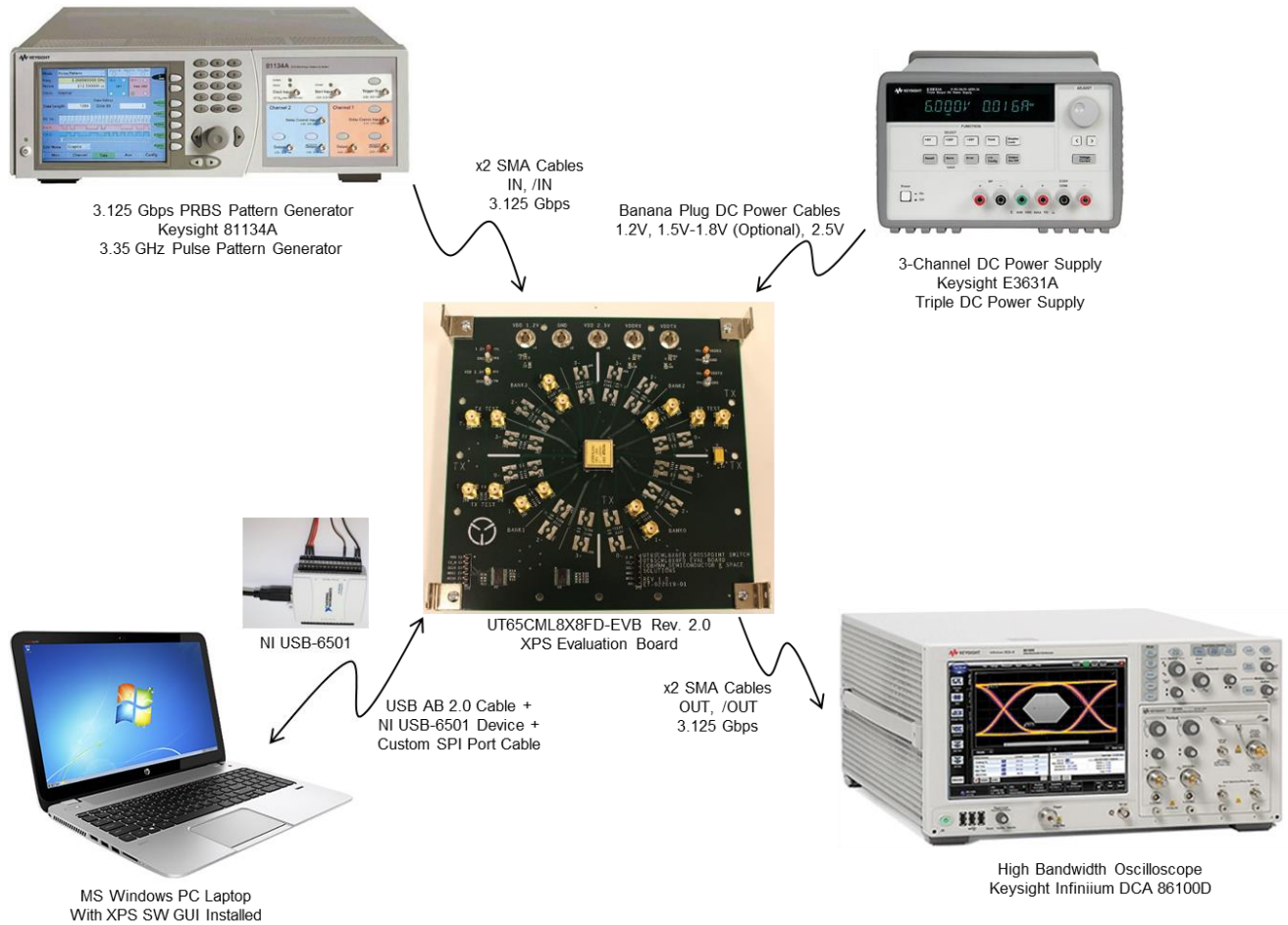

**Figure 4: Test Equipment Setup Diagram**

3.125 Gbps Crosspoint Switch (XPS)

# UT65CML8X8FD-EVB-UM Evaluation Board

## 8.0 Operating Instructions

### 8a) Hardware (HW) Setup

XPS functional overview: **Figures 5a, 5b** show the functional diagram of the UT65CML8X8FD-EVB configuration. **Figure 5a** shows all possible XPS switch connections by device programming using the SW GUI. **Figure 5b** shows the XPS default switch connections at power-up.

*In all cases, Port N RX Channel 0 connects only to Port N TX Channel 0, Port N RX Channel 1 only to Port N TX Channel 1, Port N RX Channel 2 only to Port N TX Channel 2, and Port N RX Channel 3 only to Port N TX Channel 3.* This architecture is consistent with XPS use in SpaceVPX/VITA 78-based systems as an A/B Redundancy RapidIO / XAUI port switch.

The piece-parts for only Channel 1 for all Ports 0-3 are installed with a) SMA Jacks, and b) AC-coupling capacitors. Additional channels may be populated with these piece-parts depending on user system configuration and requirements. Part numbers, manufacturers, and quantities are given in the Bill of Materials (BoM).

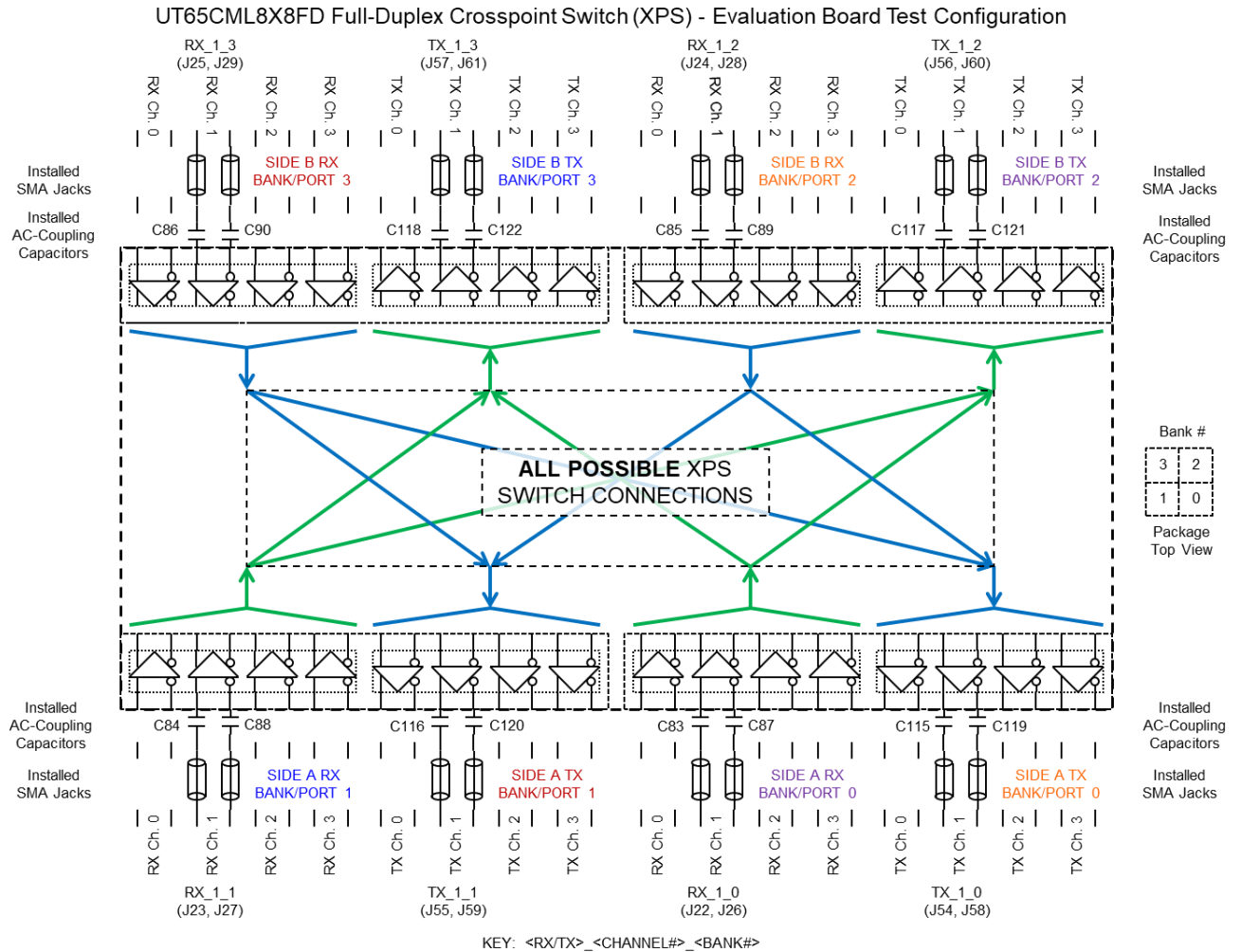
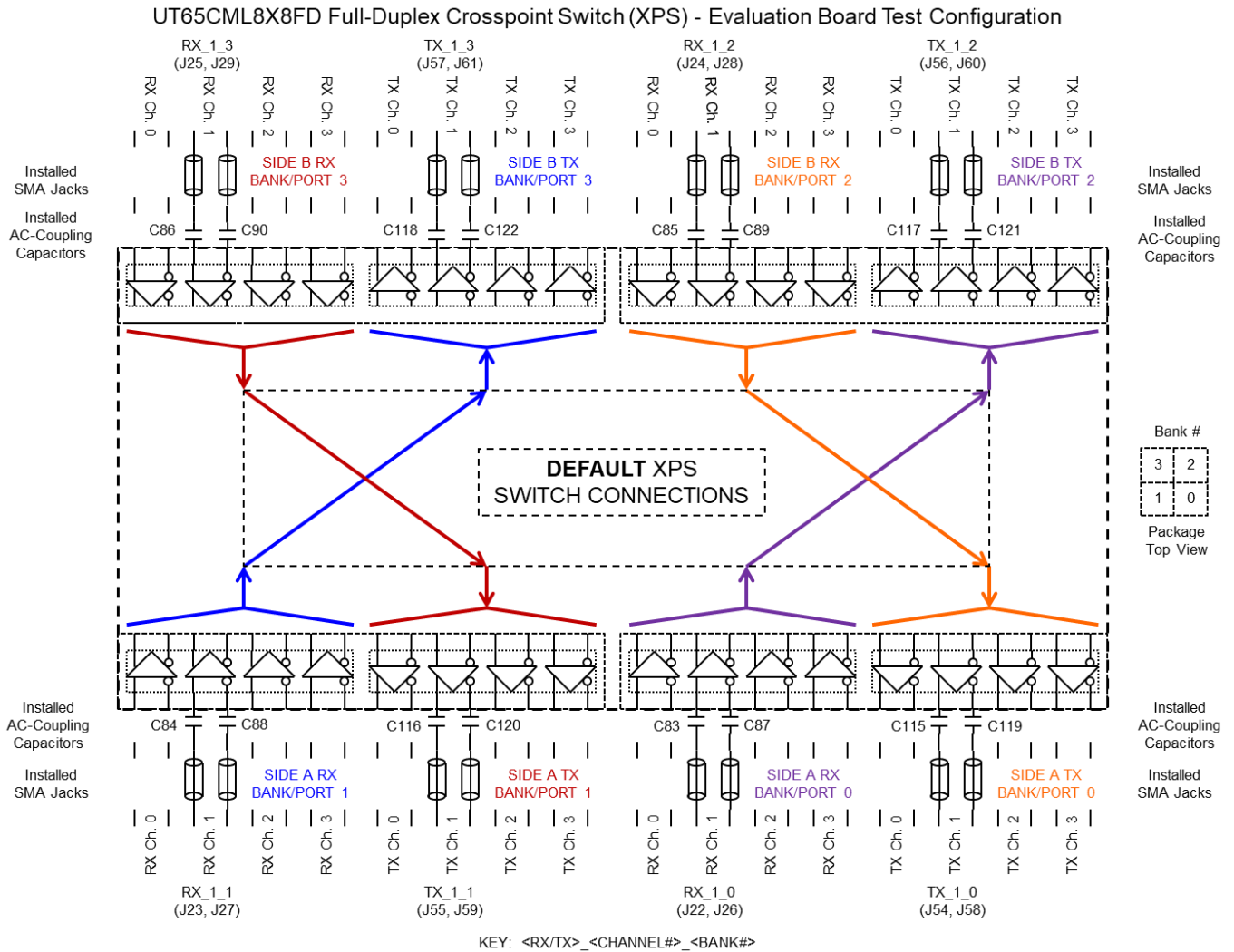

**Figure 5a: Evaluation Board Test Configuration – All Possible XPS Connections**



3.125 Gbps Crosspoint Switch (XPS)

# UT65CML8X8FD-EVB-UM Evaluation Board



**Figure 5b: Evaluation Board Test Configuration – Default XPS Connections**

Configure Hardware: Connect power, SPI interface, and high-speed signal cables, as shown in **Figures 1, 4, 6**. The UT65CML8X8FD-EVB can be oriented either horizontally (as shown), or vertically to facilitate test equipment setup. This flexible orientation is facilitated by having all high-speed RX inputs on the bottom side and all high-speed TX outputs on the top side of the EVB. See **Figures 2, 3**. Right angle SMA adapters are recommended for horizontal EVB orientation. See **Figure 6**.

Connect NI USB-6501 USB-to-SPI Interface Device (see **Figure 7**) to a) Windows PC Computer via USB AB 2.0 cable, and b) EVB Master SPI port via custom interface cable (see **Figures 7, 8**). For correct orientation of the connector to the header pins, the white wire is connected to VDD EXT and the black wire is connected to GND. See **Figures 1, 2, 7, 8**.

Now connect and configure power supplies to the EVB. The recommended initial configuration is as follows: VDD=VDDRX=VDDTX=1.20V and VDD\_25=2.5V. Power sequencing is not critical to operation of the XPS, however, we recommend core power (VDD) to power-up before, or simultaneously with I/O power (VDDRX, VDDTX) and SPI port power (VDD\_25).

# UT65CML8X8FD-EVB-UM Evaluation Board

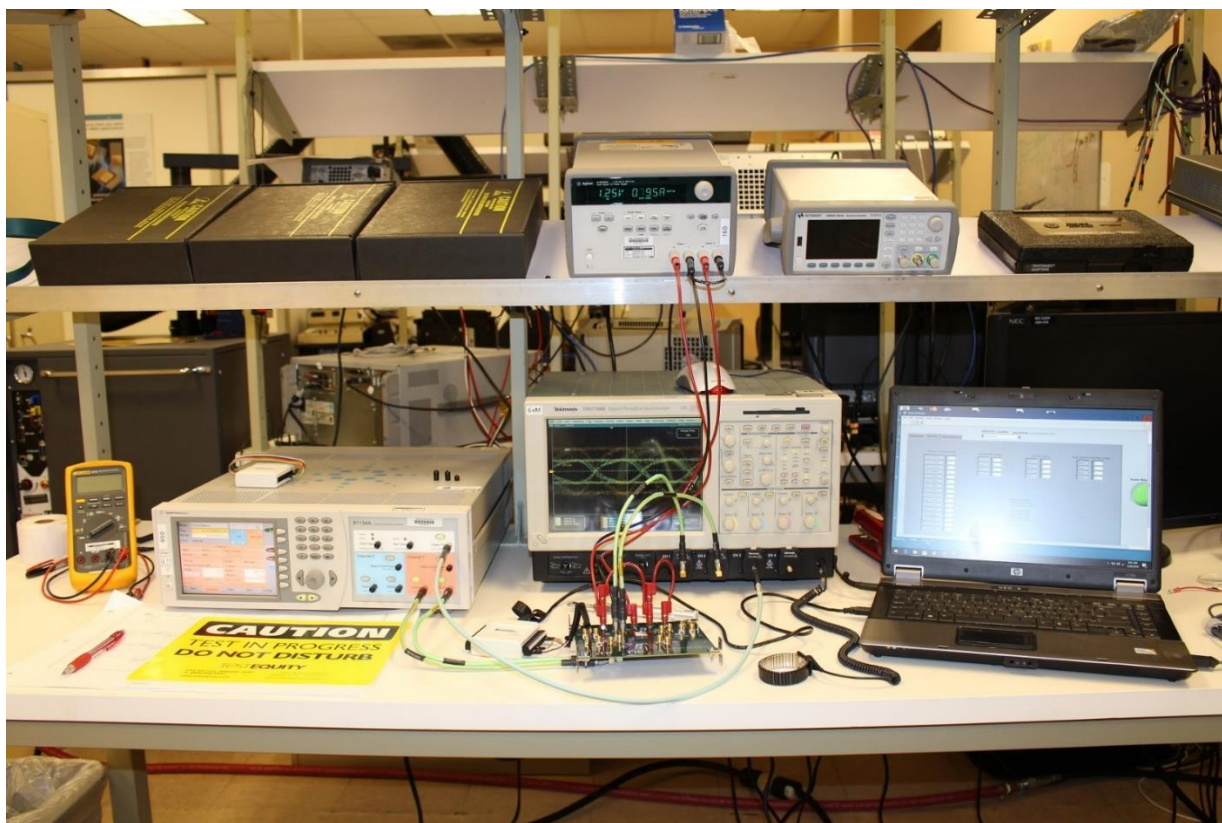
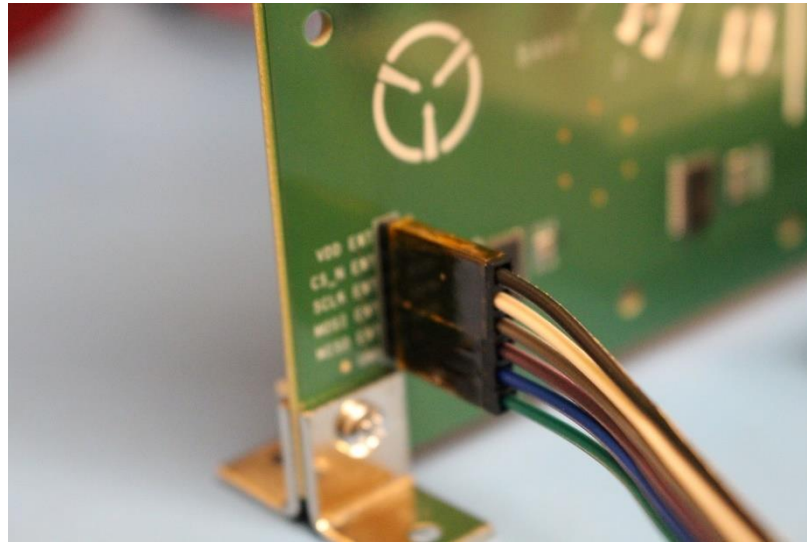

Figure 6: Example UT65CML8X8FD-EVB Test Equipment Setup



Figure 7: NI USB-6501 USB-to-SPI Interface Device - USB AB 2.0 Cable + Custom Cable Assembly Attached

# UT65CML8X8FD-EVB-UM Evaluation Board



**Figure 8: Close-up View of EVB Master SPI Port Header + Cable Assembly Connector Interface**

## 8b) Software (SW) Setup

The CAES UT65CML8X8FD-EVB XPS Evaluation Board Graphical User Interface (GUI) Software (SW) is required to configure the XPS IC via the internal registers. See register description in the Register Map section of the data sheet.

Installation instructions: Follow the installation instructions provided at website link to XPS SW GUI. Copy the indicated files to the Windows PC computer that is intended to operate the GUI. Run the installer program. After a successful GUI installation the GUI executable file "CAES XPS.exe" will be present in the run directory where the GUI SW was installed. Double-click on this executable file to start the GUI. Click on the "Run" button as shown in Figure 9. Set the PC device port for the NI USB-6501 USB-to-SPI Interface Device.

Once the GUI is operating, configure the XPS registers as required for your test configuration. Note that the XPS IC will initialize in the default setting, per the Register Map, upon power-up. Always click on the "Run" button after re-configuring the GUI settings to insure that the registers are updated with new data.

The recommended initial Receiver (RX) Equalization (EQ) setting is b'510101, or 0x15. This is different than the power-up default setting of b'501000, or 0x08. See Table 10: SPI Port Register Map, p.18-19 of the data sheet. The register names: EQ\_<3:0>\_<3:0>[4:0] and numbers: 0x04-0D are listed in the Register Map.

# UT65CML8X8FD-EVB-UM Evaluation Board

Run

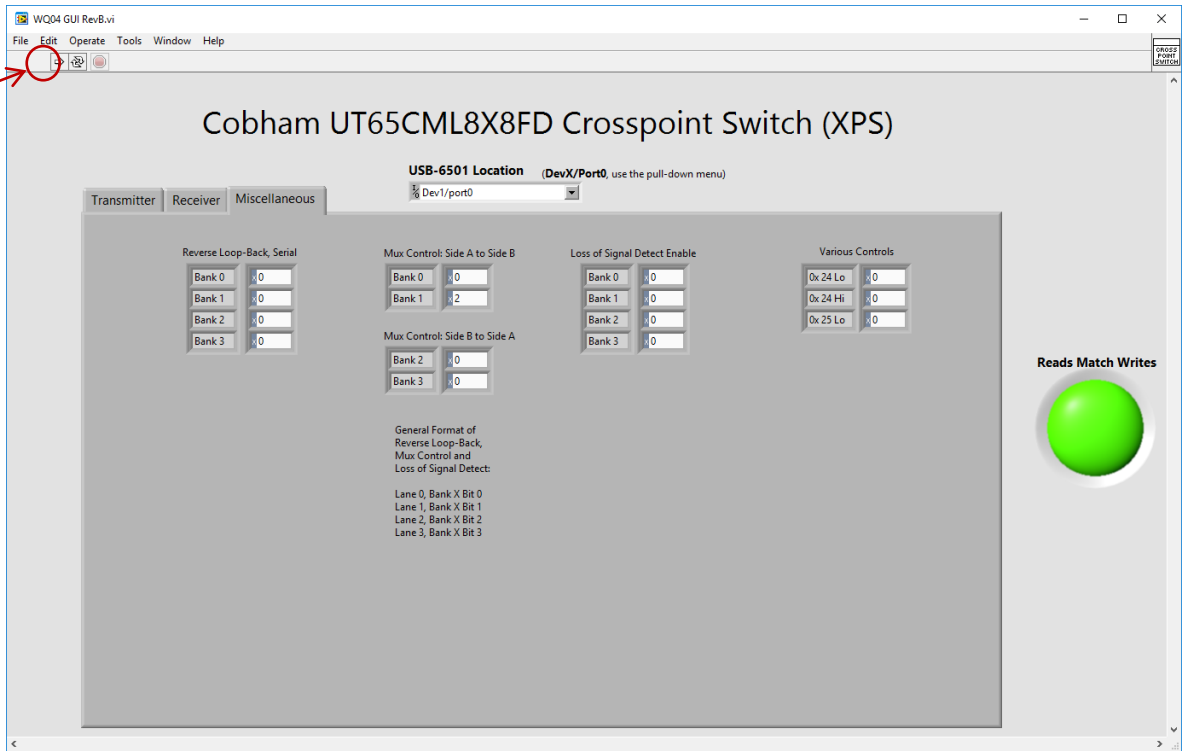

Figure 9: XPS GUI "Miscellaneous" Settings Tab Parameters

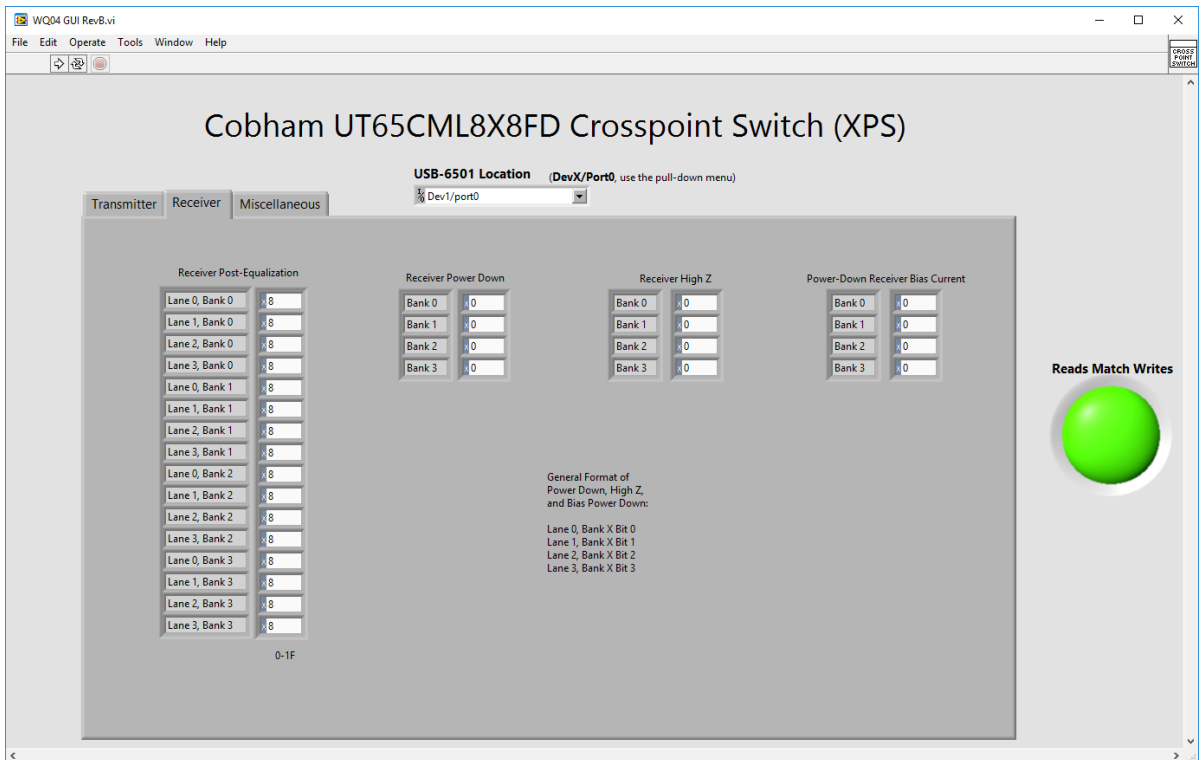

Figure 10: XPS GUI "Receiver (RX)" Settings Tab Parameters

# UT65CML8X8FD-EVB-UM Evaluation Board

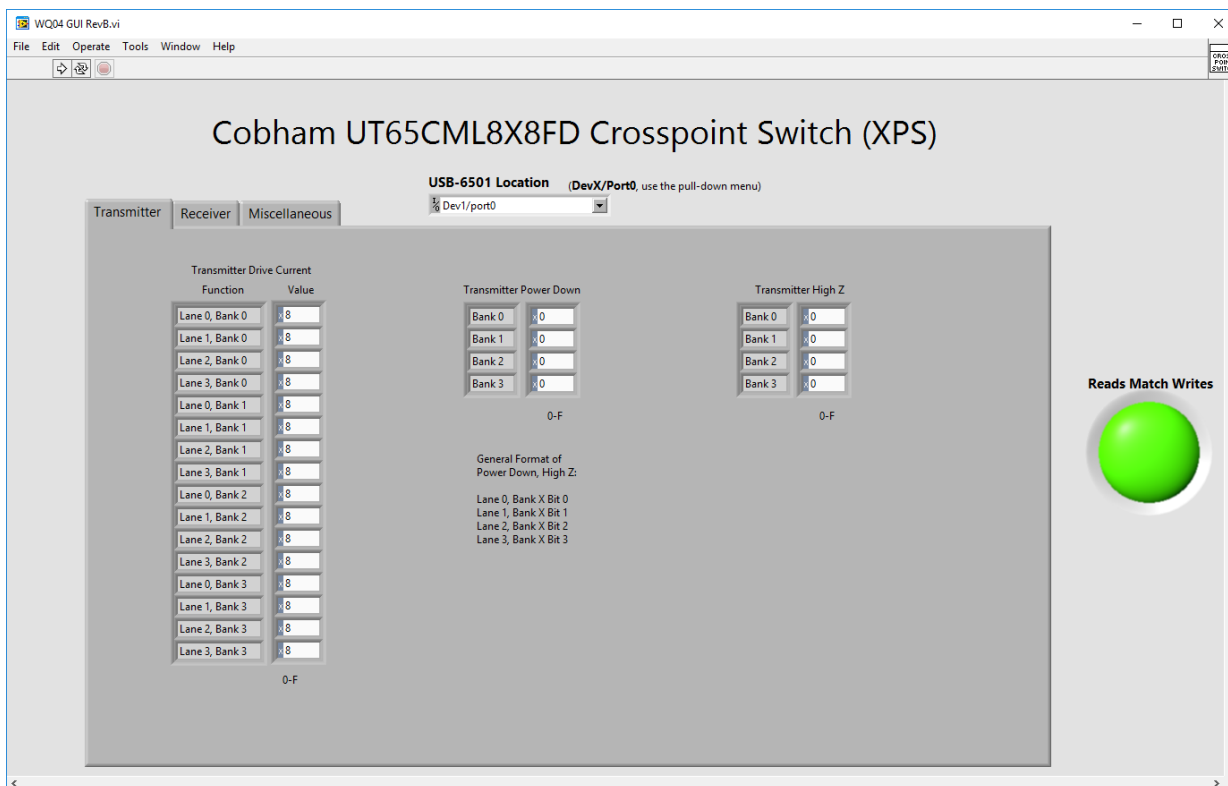

Figure 11: XPS GUI "Transmitter (TX)" Settings Tab Parameters

# UT65CML8X8FD-EVB-UM Evaluation Board

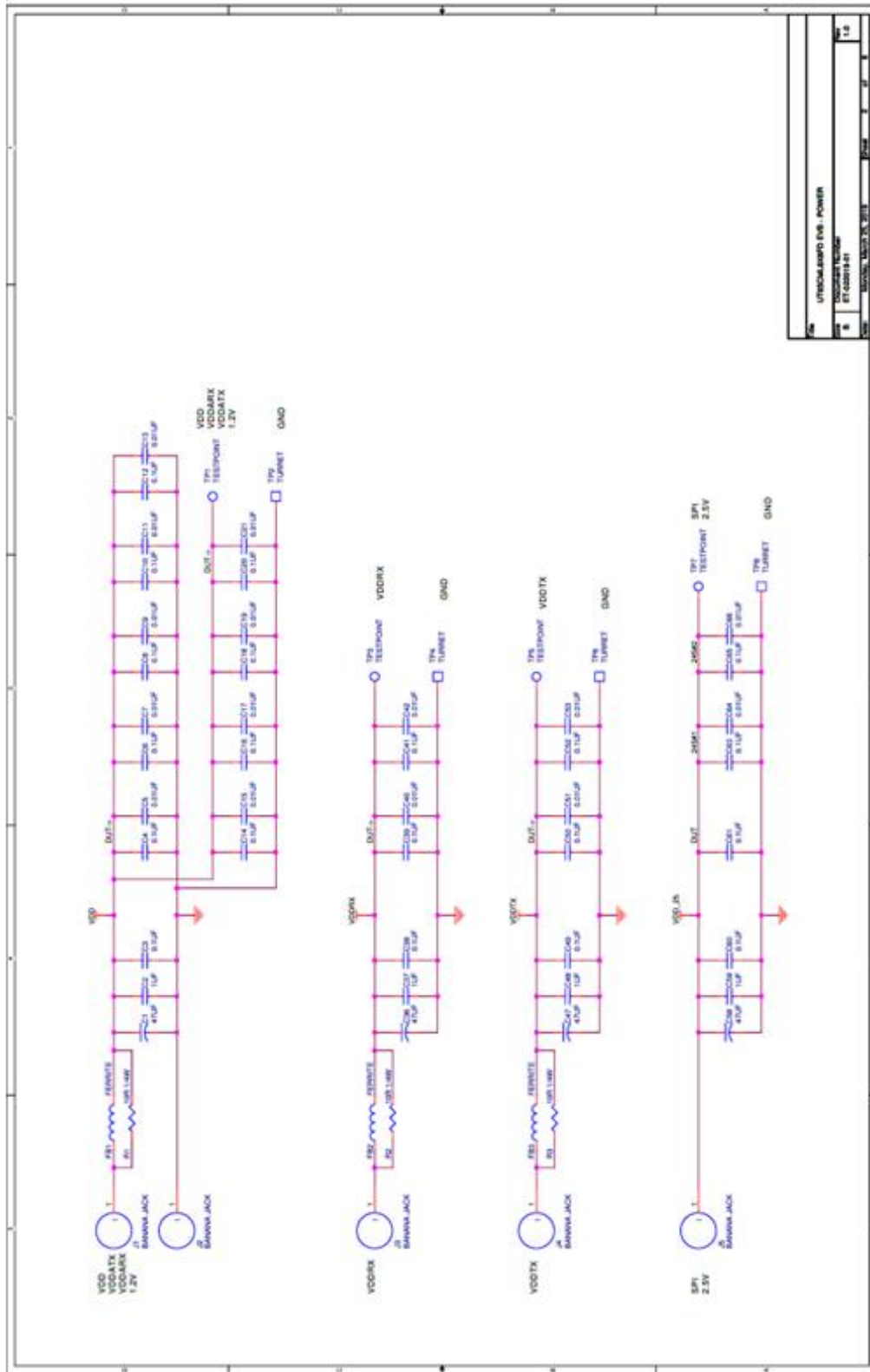

Figure 12: Schematics 1/5

# UT65CML8X8FD-EVB-UM Evaluation Board

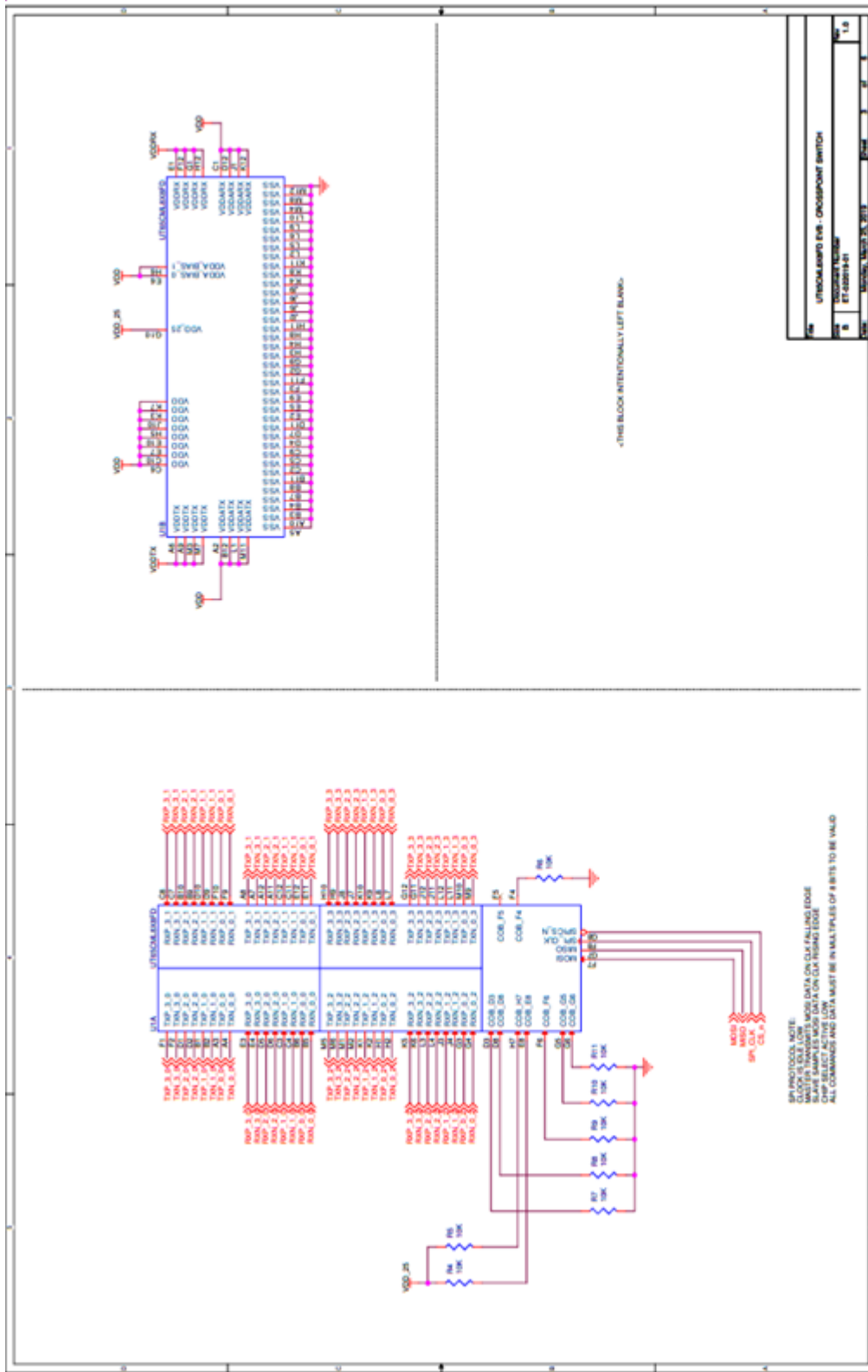

Figure 13: Schematics 2/5

Note: 04/06/22: Schematic error: TXP/N\_3\_3 are reversed; TXP\_3\_3 = Pin G11, TXN\_3\_3 = Pin G12

# UT65CML8X8FD-EVB-UM Evaluation Board

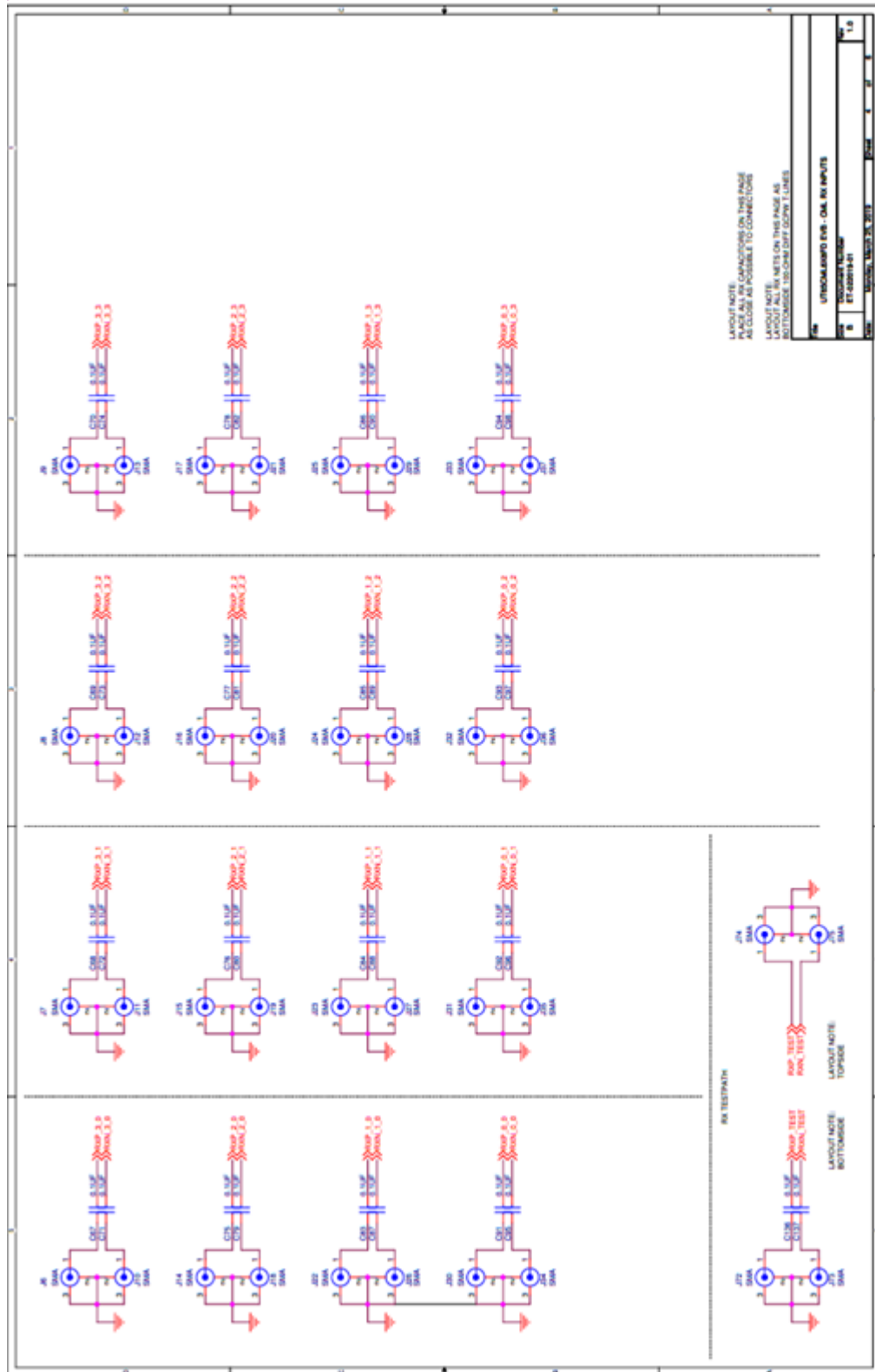

Figure 14: Schematics 3/5



3.125 Gbps Crosspoint Switch (XPS)

# UT65CML8X8FD-EVB-UM Evaluation Board

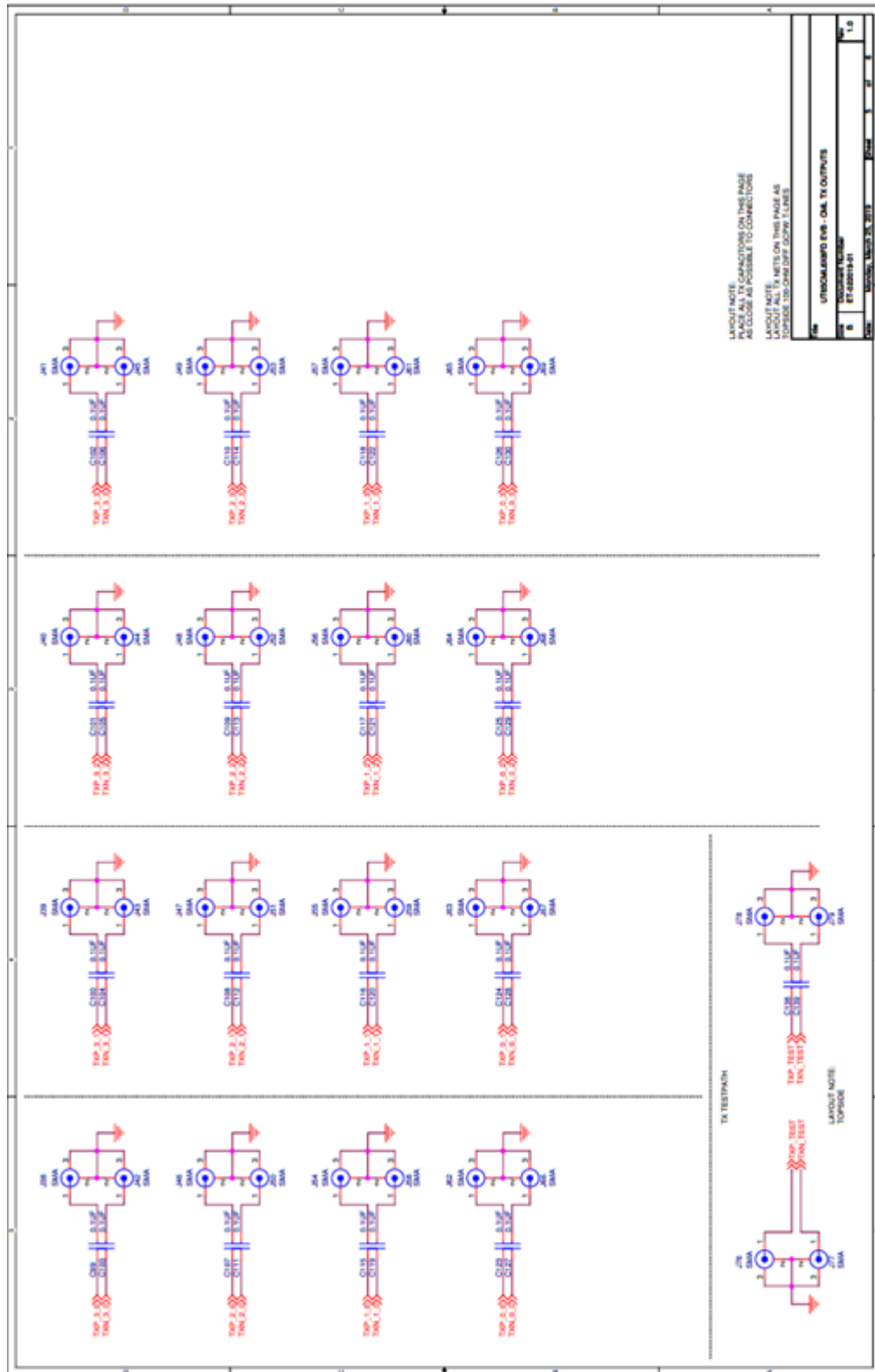

Figure 15: Schematics 4/5

Note: 04/06/22: Schematic error: TXP/N\_3\_3 are reversed; TXP\_3\_3 = Pin G11, TXN\_3\_3 = Pin G12

# UT65CML8X8FD-EVB-UM Evaluation Board

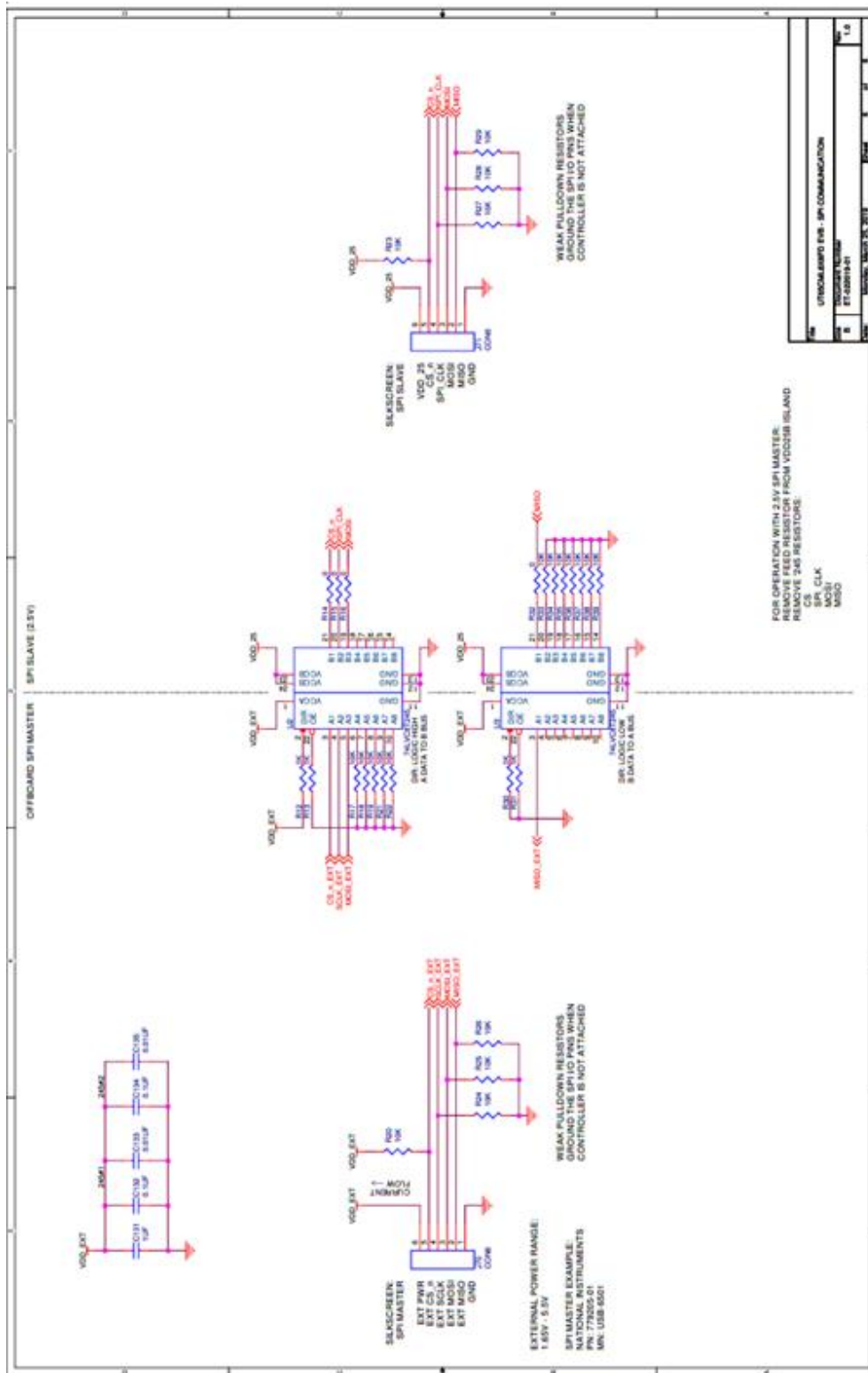

Figure 16: Schematics 5/5

3.125 Gbps Crosspoint Switch (XPS)

# UT65CML8X8FD-EVB-UM Evaluation Board

Title:	UT65CML8X8FD-EVB		BoM For x1 XPS Eval. Board (EVB)						
Rev.	1								
E#	ET-022019-01		Populate Ch. 1 Only of 4 Ch.						
Date:	22-04-06		Excludes PCB						
Author:	B. Massey								
Item #	QTY=1	Reference Designator	Part Description	PCB Footprint	Vendor	Vendor part number	Manufacturer	Part Number	Remarks
1	4	C1,C36,C47,C58	47UF	D_case	Digikey	478-6947-1-ND	AVX	TCJY476M020R0070	Out-of-Stock Replacement
2	5	C2,C37,C48,C59,C131	1UF - CAP CER 1UF 25V X8R 1206	SMT1206	Digikey	445-173789-1-ND	TDK	CGASL2X8R1E105K160AE	Out-of-Stock Replacement
3	4	C3,C38,C49,C60	0.1UF	SMT0805	Digikey	478-11447-1-ND	AVX	0805YC104JAT2A	
4	18	C4,C6,C8,C10,C12,C14,C16,C18,C20,C39,C41,C50,C52,C61,C63,C65,C132,C134	0.1UF	SMT0402	Digikey	445-5613-1-ND	TDK	CGA2B1X7R1C104K050BC	
5	17	C5,C7,C9,C11,C13,C15,C17,C19,C21,C40,C42,C51,C53,C64,C66,C133,C135	0.01UF	SMT0402	Digikey	478-3664-1-ND	AVX	0402YC103JAT2A	
6	20	C83,C84,C85,C86,C87,C88,C89,C90,C115,C116,C117,C118,C119,C120,C121,C122,C136,C137,C138,C139	0.1UF - 16V X7R 0402 16kHz-18GHz	SMT0402	Digikey	1284-1591-1-ND	ATC	530L104KT16T	Populate Ch. 1 Only of 4 Ch. + Populate RX+TX Test Paths
7	3	FB1,FB2,FB3	FERRITE - 1kQ@100 MHz 0805 1.5A 150mQ	SMT0805	Digikey	445-172904-1-ND	TDK Corporation	MP220125102ATD25	Out-of-Stock Replacement
8	5	J1,J2,J3,J4,J5	BANANA JACK	MH256_PLATED	Digikey	501-1115-ND	Pomona	3267	
9	24	J22,J23,J24,J25,J26,J27,J28,J29,J54,J55,J56,J57,J58,J59,J60,J61,J72,J73,J74,J75,J76,J77,J78,J79	SMA VERTICAL JACK	SMA_J819_SMT_TEARDROP10	Digikey	J819-ND	Cinch	142-0711-201	Populate Ch. 1 Only of 4 Ch. + Populate RX+TX Test Paths
10	2	J70,J71	CON6	6x1_header	Digikey	S1011EC-06-ND	Sullins	PRPC006SAAN-RC	
11	3	R1,R2,R3	10 - RES 10 OHM 1% 1/4W 1206	SMT1206	Digikey	RMCF1206FT10R0CT-ND	Stackpole Electronics Inc	RMCF1206FT10R0	Out-of-Stock Replacement
12	28	R4,R5,R6,R7,R8,R9,R10,R11,R17,R18,R19,R20,R21,R22,R23,R24,R25,R26,R27,R28,R29,R33,R34,R35,R36,R37,R38,R39	10K - RES 10K OHM 1% 1/10W 0603	SMT0603	Digikey	RMCF0603FT10K0CT-ND	Stackpole Electronics Inc	RMCF0603FT10K0	Out-of-Stock Replacement
13	4	R12,R13,R30,R31	1K - RES 1K OHM 1% 1/10W 0603	SMT0603	Digikey	RMCF0603FG1K00CT-ND	Stackpole Electronics Inc	RMCF0603FG1K00	Out-of-Stock Replacement
14	4	R14,R15,R16,R32	0 - RES 0 OHM JUMPER 1/10W 0603	SMT0603	Digikey	RMCF0603ZTOR00CT-ND	Stackpole Electronics Inc	RMCF0603ZTOR00	Out-of-Stock Replacement
15	1	TP1	TESTPOINT	TP_40D	Digikey	36-5000-ND	Keystone	5000	
16	4	TP2,TP4,TP6,TP8	TURRET	Turret_1502A	Digikey	36-1502-2-ND	Keystone	1502-2	
17	2	TP3,TP5	TESTPOINT	TP_40D	Digikey	36-5003-ND	Keystone	5003	
18	1	TP7	TESTPOINT	TP_40D	Digikey	36-5004-ND	Keystone	5004	
19	1	U1	UT65CML8X8FD	143LGA_1mm_14mm5	CAES	WQ04AAE3OANAA	Cobham	UT65CML8X8FD	3.125 Gbps XPS IC, C-BGA Pkg.
20	2	U2,U3	74LVC8T245	TSSOP24	Digikey	296-18593-1-ND	TI	SN74LVC8T245PWR	Level Translator IC
21	8	HDWE1	BRACKET UNIVERSAL CLEAR HOLE		Digikey	36-4335-ND	Keystone	4335	
22	4	SCREW 4-40x1/2 PHILLIPS	MACHINE SCREW PAN PHILLIPS 4-40		Digikey	H346-ND	B&F Fastener	PMS 440 0050 PH	
23	4	HEX NUT 4-40	HEX NUT 1/4" STEEL 4-40		Digikey	36-9600-ND	Keystone	9600	
24	1	WIRE1	JUMPER M/F 11.811" 1PC x40 WIRES/ZIP		Digikey	1528-1160-ND	Adafruit	824	USB-to-SPI Cable x4/x6 Wire ea.
25	1	POD1	USB-6501 DIGITAL I/O DEVICE (POD)		Solubit		NI	779205-01	USB-to-SPI Converter Pod
26	1	ESDBAG1	BAG STATIC METL-IN 8X10" 1=1EA		Digikey	SCP309-ND	SCS	100810	Static Shielding Bag, 8"x10"
27	1	BOX1	Corstat 3230-6 Conductive Circuit Board Shipper W/ ESD Foam, 10-1/2" X 8-1/2" X 2-1/2"		Digikey	2079-3230-6-ND	Conductive Containers, Inc.	3230-6	Out-of-Stock Replacement

Figure 17: Bill of Materials (BoM)

## 3.125 Gbps Crosspoint Switch (XPS)

# UT65CML8X8FD-EVB-UM Evaluation Board

## 11.0 EVB Layout Information

The UT65CML8X8FD-EVB Evaluation Board PCB layout information will be made available at the product website.

## 12.0 Revision History

Date	Revision	Change Description
18-08-01	0.0.1	DRAFT INITIAL VERSION
18-08-08	0.0.2	DRAFT REVISION – BoM update for 1 of 4 channels populated
18-08-08	0.1.0	INITIAL RELEASE
19-06-10	2.0.0	Document update for Eval. Board Rev. 2.0
22-04-06	2.1.0	Updates: a) Doc. format, b) USB-to-SPI Cable photos, c) BoM Errata: Schematic error: TXP_3_3 = Pin G11, TXN_3_3 = Pin G12

The following United States (U.S.) Department of Commerce statement shall be applicable if these commodities, technology, or software are exported from the U.S.: These commodities, technology, or software were exported from the United States in accordance with the Export Administration Regulations. Diversion contrary to U.S. law is prohibited.

***Cobham Colorado Springs Inc. d/b/a Cobham Advanced Electronic Solutions (CAES) reserves the right to make changes to any products and services described herein at any time without notice. Consult an authorized sales representative to verify that the information in this data sheet is current before using this product. The company does not assume any responsibility or liability arising out of the application or use of any product or service described herein, except as expressly agreed to in writing; nor does the purchase, lease, or use of a product or service convey a license under any patent rights, copyrights, trademark rights, or any other of the intellectual rights of the company or of third parties.***